

## 01.19.DA Option Front Bumper Cover (Remove for Access and Install)

- ▣ WSM Data
- ▣ Included Procedures
- ▣ Is Used In

### *Remove for Access*

1. Remove the front undertray (01.02.NB - Front Undertray).  
[[Open Workshop Manual Procedure](#)]
2. Remove right side headlamp assembly (17.01.AB - Right Side Headlamp Assembly).  
[[Open Workshop Manual Procedure](#)]
3. Remove left side headlamp assembly (17.01.BB - Left Side Headlamp Assembly).  
[[Open Workshop Manual Procedure](#)]
4. Release the front bumper harness connectors from the clip.
5. Disconnect the electrical connector for the Parking Assistance Camera from the

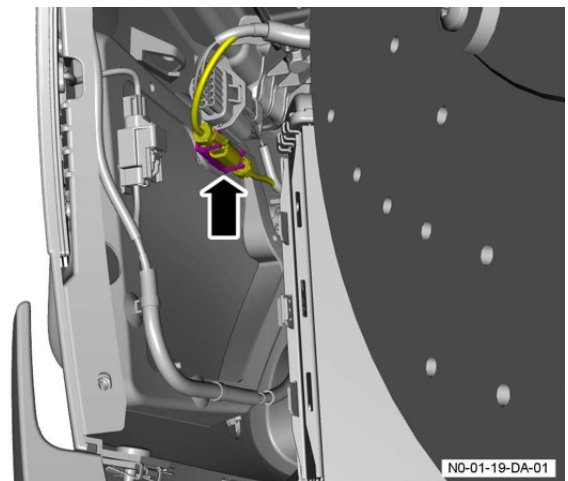

forward harness.

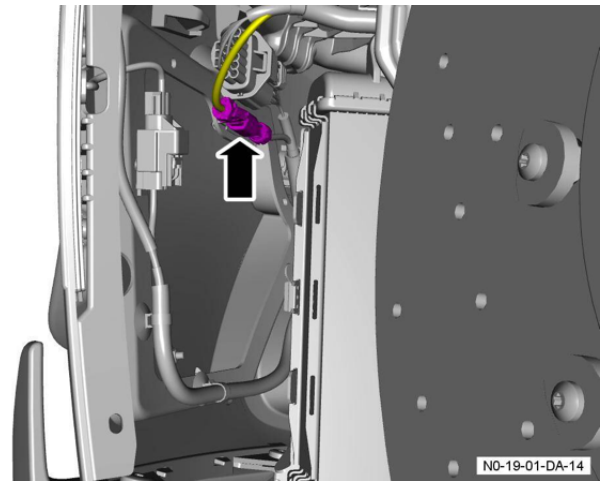

6. Disconnect the electrical connector for the front bumper harness from the forward harness.

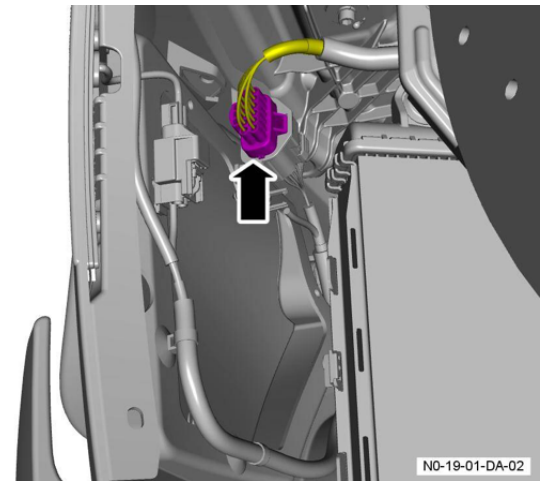

7.  *Note: This step only applies to F1 Edition vehicles.*

Remove the three bolts that attach the front splitter to the splitter bracket.

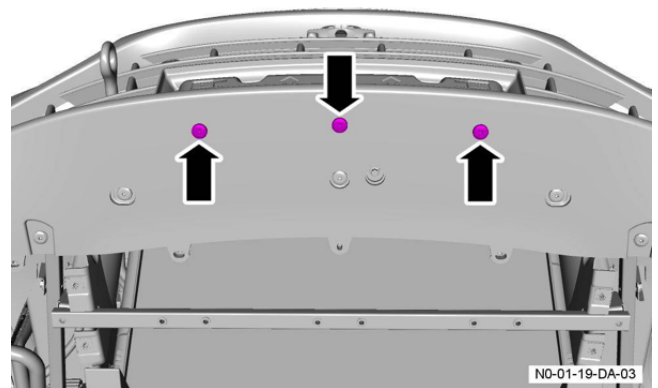

8. Remove the three bolts that attach the option front bumper cover to the splitter support bracket.

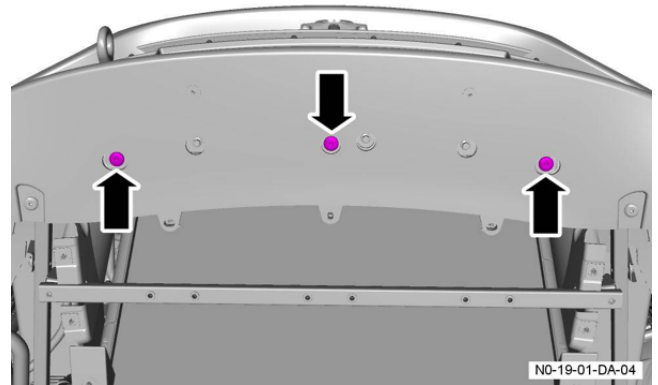

9. **i** *Note: To keep the correct front bumper cover adjustment do not rotate the double stud adjuster during the following step.*

Remove the nut that attaches the front bumper cover to the double stud adjuster and collect the washer.

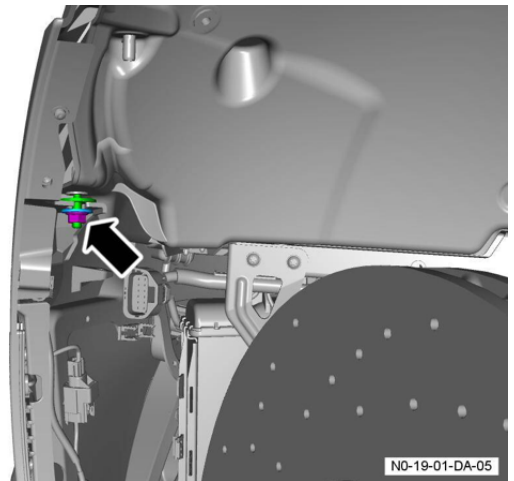

10. **i** *Note: To keep the correct front bumper cover adjustment do not rotate the double stud adjuster during the following step.*

Remove the nut that attaches the front bumper cover to the double stud adjuster and collect the washer.

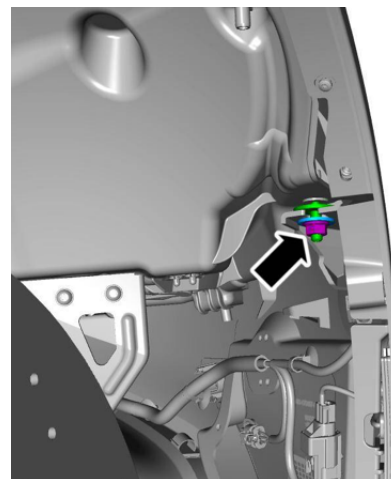

11. **i** *Note: To keep the correct front bumper cover adjustment do not rotate the double stud adjuster*

*during the following step.*

Remove the nut that attaches the front bumper cover to the double stud adjuster and collect the washer.

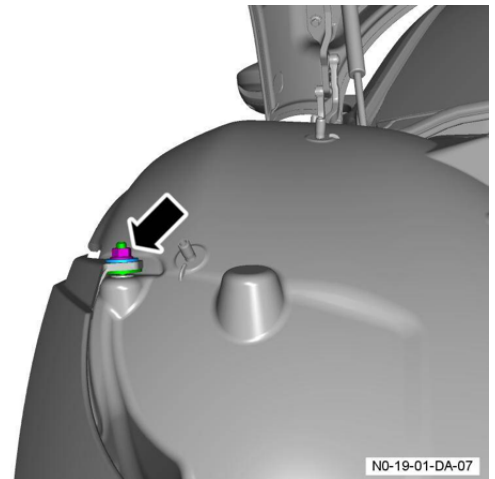

12.  *Note: To keep the correct front bumper cover adjustment do not rotate the double stud adjuster during the following step.*

Remove the nut that attaches the front bumper cover to the double stud adjuster and collect the washer.

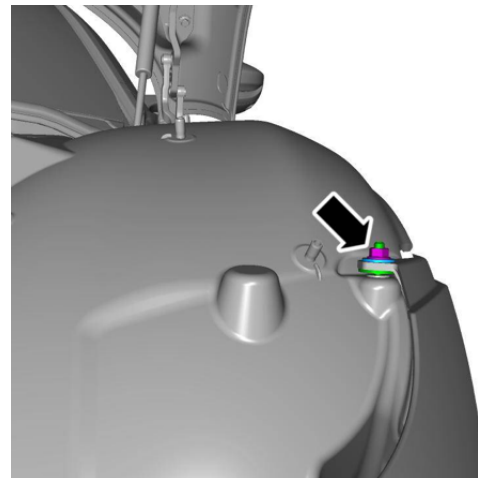

13. Remove the bolt that attaches the front bumper cover to the body and collect the washer.

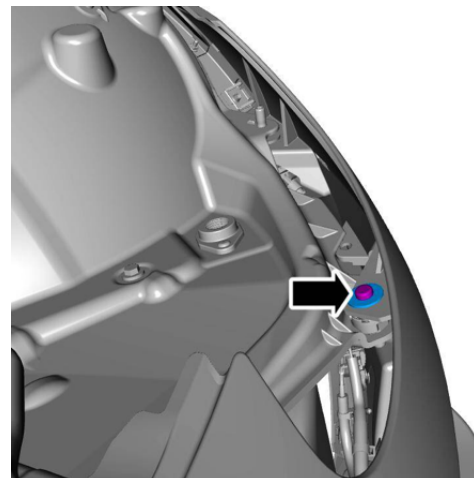

14. Remove the bolt that attaches the front bumper cover to the body and collect the washer.

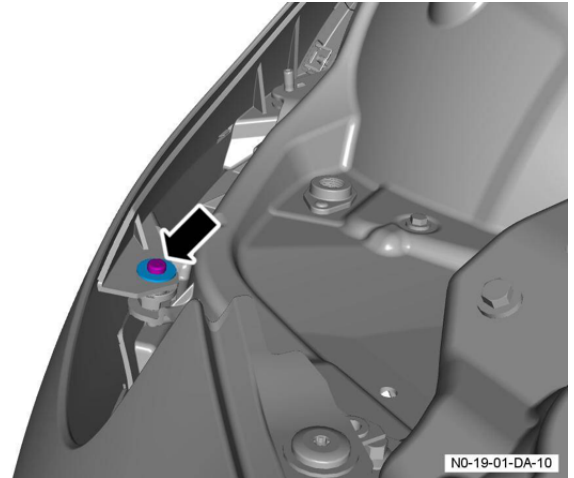

15. Remove the six bolts that attach the front bumper cover to the body and collect the washers.

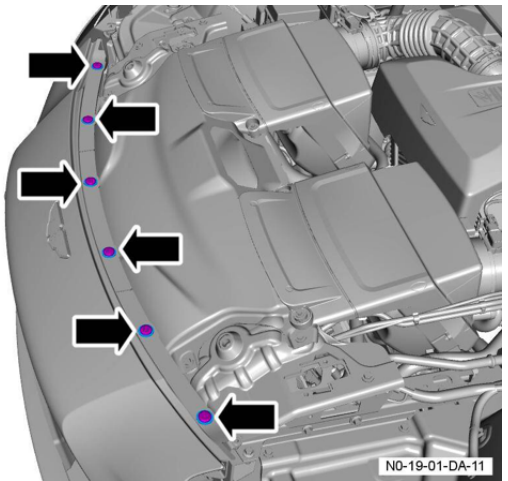

16. Release the front bumper cover from the body.

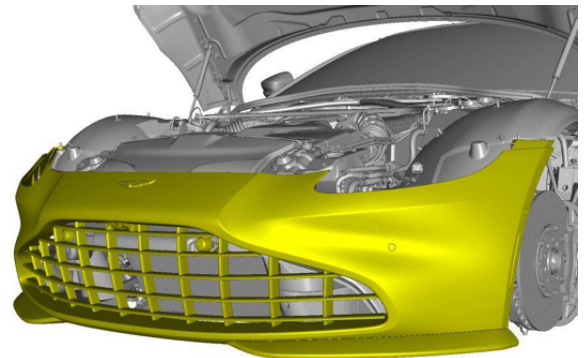

17. Remove the option front bumper cover.

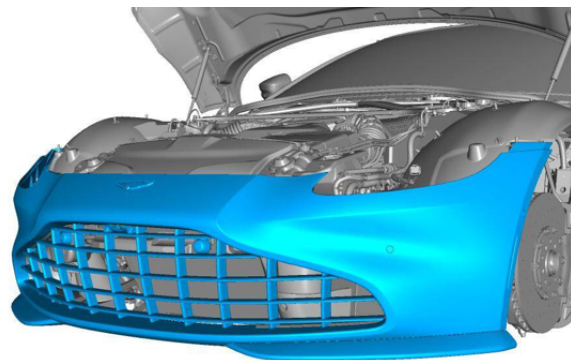

NO-19-01-DA-13

---

## *Install*

1. Installation is the opposite of the removal sequence.

Published date: 2021-05-13 Procedure last changed: 2021-05-20 20:15:30